

A Guide to the Reduction of Traffic Noise

For use by Builders, Designers & Residents



ISBN 0 7306 22231

First Edition 1994

Reprint 2003

Contents

| | |
|---|-----------|
| 1. The Problem | 1 |
| 2. Some Characteristics of Noise | 1 |
| 3. Reducing Noise at the Source | 3 |
| 4. VicRoads' Practices | 3 |
| New Roads | 4 |
| Existing Roads | 4 |
| 5. Opportunities for Noise Reduction in New Homes | 4 |
| Site Planning to Reduce Traffic Noise | 4 |
| Architectural Design to Reduce Traffic Noise | 6 |
| Acoustic Construction | 6 |
| 6. Opportunities for Noise Reduction in Existing Homes | 7 |
| 7. Step by Step Approach to Reducing Annoyance Caused by Traffic Noise | 7 |
| Determine the Nature of the Problem | 7 |
| 8. Noise Barrier Principles | 8 |
| Materials | 9 |
| Construction | 9 |
| Location | 11 |
| Screen Walls | 11 |
| Aesthetics | 13 |
| 9. Earth Mounds and Vegetation | 14 |
| 10. Sound Insulation of Buildings | 15 |
| Principles | 15 |
| Windows | 15 |
| Stage 1 | 16 |
| Stage 2 | 18 |
| External Doors | 20 |
| Stage 1 | 20 |
| Stage 2 | 20 |
| Ceiling and Roofs | 21 |
| Walls | 21 |
| Floors | 22 |
| Ventilation | 22 |
| Room Furnishings and Absorption | 24 |
| 11. Your Responsibility for the Noise Environment of Others | 25 |
| 12. Information on Acoustic Materials | 25 |
| Additional Notes on Supplies of Acoustic Materials | 26 |
| 13. Reference for Further Reading | 26 |



1. The Problem

Periodically requests are received for advice on ways to reduce traffic noise within living areas. While there is considerable technical material available, it is often not easily accessible to the public. This booklet has been prepared as a guide for those wanting to know what practical steps they can take to reduce the level of traffic noise and the annoyance it causes.

The solution to any one person's noise problem depends on the extent to which they are annoyed by the noise, or on the degree to which it interferes with various activities around and within the home. In the community there is a wide range of sensitivity to noise. For a given level of traffic noise, there will be a wide range of responses. Some people are likely to become disturbed at a relatively low level of traffic noise, while others may not be disturbed even at relatively high levels. Similarly a range of individual responses could be expected for any given change in noise level.

Tolerance to noise is influenced by the degree of acclimatisation, the level and nature of the intruding noise and the level of the background or ambient noise. The annoyance a person feels is also influenced by the extent to which traffic noise interferes with particular activities. For example, reading, sleeping or watching television can heighten a person's sensitivity to noise.

2. Some Characteristics of Noise

The ear is sensitive to sound pressure. Sound waves represent tiny oscillations of pressure in the air, just above and just below atmospheric pressure. These pressure oscillations impinge on the ear and we "hear the sound".

Sound pressure can be measured but the audible sounds cover an enormous range of pressures and involve large numbers. The sound pressure near a powerful jet engine may be a million times the sound pressure of a very quiet whisper.

Noise is measured on a logarithmic scale so that numbers describing levels of sound pressure are more manageable. The units of this scale are decibels (dB). The logarithmic scale also corresponds well with the way the human ear responds to increases in sound pressure or volume.

The logarithmic decibel scale is extremely useful, however, it can be puzzling. On a linear scale, the total sound pressure due to two identical noise sources would be twice that of one of the sources operating alone. However, on a logarithmic scale, the total sound pressure level resulting from two identical noise sources is 3 dB higher than the level produced by either source alone.

The discussion above has referred to sound pressure, however, although the perceived loudness of a sound depends primarily on sound pressure, it is also influenced by frequency. The human ear is most sensitive to mid-band or high frequencies and is less sensitive to sound in the lower frequency range. Because of this varying sensitivity, a weighting scale is used. It is known as the "A" scale and the units are referred to as "A" weighted decibels and written dB(A) scale discriminates between sounds in much the same way that people do.

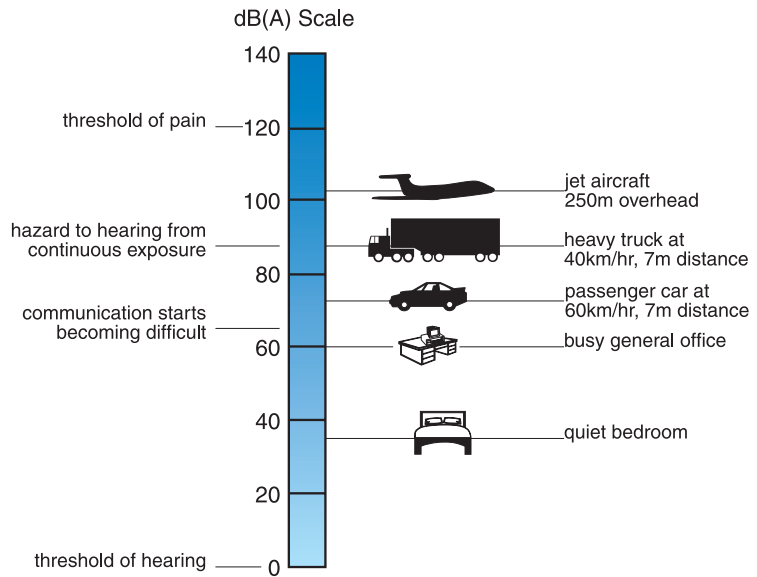

To appreciate the effects of noise reduction measures some characteristics of traffic noise and its behaviour should be noted. Noise energy in the form of sound waves carried by air weakens as the distance from the source to the listener becomes greater. With a doubling of the distance between a listener and a stream of traffic, the noise passing over open hard ground, is reduced by about 3 dB(A).

As can be readily appreciated a doubling of the traffic volume will double the amount of noise energy. However, this doubling of the energy increases the noise level by 3 dB(A). The graph below illustrates the effect that increasing traffic volumes has on noise level.

It should be noted that a change of 3dB(A) in traffic noise levels is just perceptible. Also, a noise level change of 10dB(A) is a doubling or halving of the loudness.

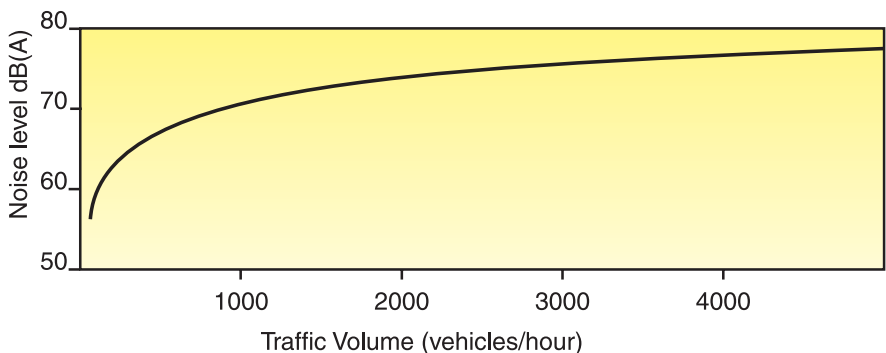

3. Reducing Noise at the Source

At low traffic speeds such as those normally experienced on urban roads, the majority of road traffic noise is caused by vehicle engines, transmissions, exhausts and brakes. As speeds rise, the noise attributable to the interaction of the tyre on the road, as well as to air disturbance, increases.

Legislation exists to progressively reduce the noise emitted from all new vehicles in Australia. Given that motor vehicles have a long working life, the effect of the legislation will only be evident in the long term.

The reduction of truck noise should have a significant benefit in the long term by lowering maximum noise levels, as well as improving the overall noise environment.

Responsible driver behaviour and correct vehicle maintenance can also lessen the annoyance caused by traffic noise.

4. VicRoads' Practices

VicRoads is concerned about the levels of traffic noise, and during investigations for new road routes the prediction of traffic noise levels for the various alternatives is undertaken as part of the planning process.

Road planning involves the estimate of the traffic noise impacts on sensitive use areas. These areas include residential dwellings, hospitals, motels as well as schools, libraries, etc. Noise amelioration is considered when the predicted level exceeds 63dB(A) L10(18 hour).

L10 (18 hour) is a measure of daily exposure to traffic noise. It is calculated by averaging the L10's for each of the eighteen hours between 6am and midnight. The L10 for each hour is the noise level in dB(A) which is exceeded for 10% of that hour. The L10 (18 hour) index generally describes the peaks of traffic noise and provides an indication of how much the prevailing traffic noise will annoy exposed residents.



Noise barrier on top of earth mound

New Roads

VicRoads traffic noise planning for roads on new alignments is to reduce the noise impact at the most exposed facade of the building to 63dB(A), where practicable.

Further, where properties are acquired for road widening and the remaining residences are exposed to higher levels of traffic noise the 63 dB(A) objective will apply. It should be noted that this policy only applies to the lowest level of a building.

Where the existing noise level is 50dB(A) or less, VicRoads will consider limiting the increase in noise from the new road to 12dB(A).

Existing Roads

When the noise level from an existing road covered by VicRoads policy, exceeds 68dB(A) consideration will be given to reducing the noise levels to less than 68dB(A), and eventually less than 63dB(A).

VicRoads does not attenuate traffic noise generated by the arterial road network, unless works are undertaken to significantly increase the road's traffic carrying capacity.

Exception to the Policy

VicRoads will not ameliorate traffic noise where new buildings or subdivisions are built next to an existing or future road controlled by VicRoads.

5. Opportunities for Noise Reduction in New Homes

Where allotments are so located that houses built on them will be affected by traffic noise, it is desirable that good acoustic design and construction techniques are used. New houses can be designed, built and located on sites so that the effect of traffic noise is minimised.

Site Planning to Reduce Traffic Noise

Acoustic site planning involves the careful arrangement of buildings on a site so as to minimise the affect of traffic noise. The techniques can be best used on large sites such as cluster subdivisions, but some ideas can be applied to average suburban home sites.

Some principles of acoustic site planning are:

- place as much distance as possible between the noise source such as a road, and noise sensitive areas such as bedrooms. Noise reduces as the distance from the source to the listener becomes greater;
- place noise compatible areas such as parking lots, open space and garages between the noise source and the noise sensitive areas;
- use the house and other buildings as barriers to protect or shield outdoor living areas, for example a house with a courtyard or barbecue area on the shielded side;

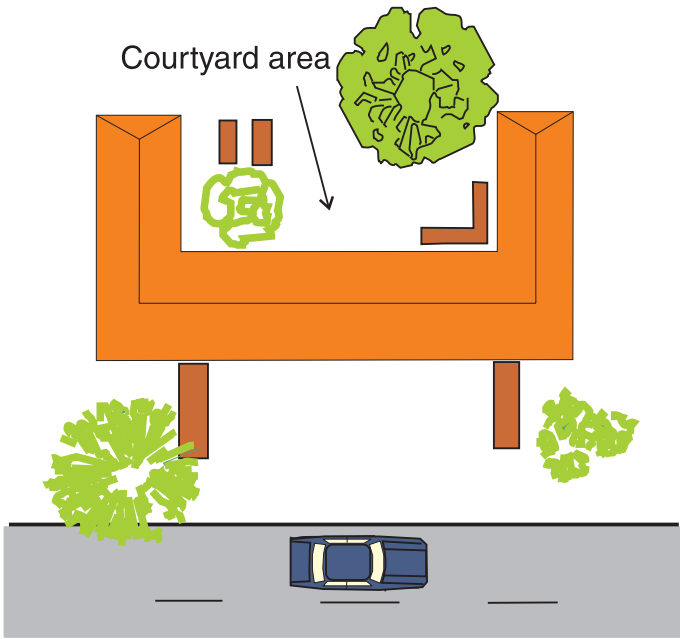
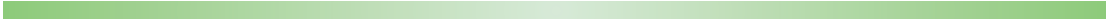

Acoustic Site Planning: Use of courtyard design to obtain quiet outdoor environment

- exploit natural features such as slopes. By excavating, houses can be more effectively shielded from traffic noise; and
- where possible use excavated material to form mounds to provide protection. These mounds can then be shaped and planted to look like natural features.

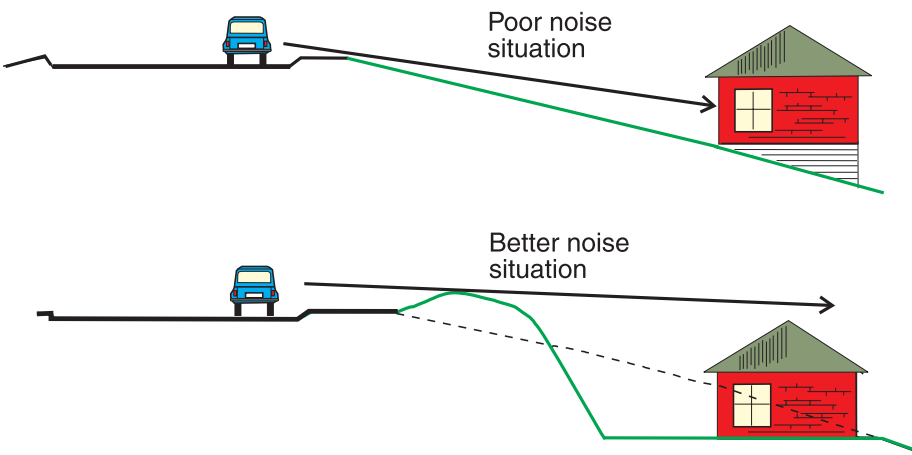

Use of natural slope of land to maximise noise shielding.



Architectural Design to Reduce Traffic Noise

Architectural acoustic design involves such aspects as building height, room arrangement, placement of windows and courtyard design. Bedrooms and living rooms, for example, are best placed in that part of the building which is furthest from the noise source. Bathrooms, laundries and toilets are areas where activities are more tolerant of noise, and these areas can act as a buffer for more sensitive areas.

Noise entering a house can be reduced by eliminating or reducing the size of windows in the walls which face the roadway. Noise impact can also be great for rooms with walls perpendicular to the roadway. A partial solution for these rooms could be a screen wall to shield the windows. (Refer Section 8 - 'Noise Barriers').

Single storey house designs generally have greater potential for protection from traffic noise than do two storey dwellings. Two storey houses generally require a higher level of acoustic construction in the upper storey because of reduced shielding from noise barriers and adjacent buildings. In any case the path of the sound waves should be considered during building design.

Acoustic Construction

Acoustic building construction combines the selection of appropriate materials and the treatment of various parts of a building to reduce interior noise. The use of dense insulating materials and the use of air spaces between and within materials are the principal noise reduction techniques. Acoustical construction includes treatment and the special design of walls, windows, doors, ceilings and ventilators.

Acoustic construction can be an expensive technique, especially when added to an existing building, however, it need not be prohibitively expensive in new buildings. It is one of the most effective ways of reducing the intrusion of outside noise.

6. Opportunities for Noise Reduction in Existing Homes

Existing home owners with a noise problem often react by erecting a high wall or fence to keep out the noise. A fence can be effective (providing it is built to standards set out later in this booklet) in reducing traffic noise. A high fence can lower the outdoor noise level and therefore be effective in improving the indoor noise environment also.

In some situations only the traffic noise reaching the inside of the house is of concern. Here the resident must decide whether money is better spent on a high fence or on improving the sound



A suggested house layout with arterial road at front. Bedrooms are to the rear of the house with garage forming sound barrier.

reducing or insulating properties of the house. For a brick house, money may be better spent upgrading windows rather than on a high fence. Later chapters of this booklet are intended to help you decide on the most appropriate course of action.

7. Step by Step Approach to Reducing Annoyance Caused by Traffic Noise

In some cases, overcoming the noise problem may be relatively simple and achieved at little cost, particularly if noise inside the house is the only concern.

Determine the Nature of the Problem

In which rooms is the noise level of concern and at what time of the day? Does simply closing the windows reduce the noise sufficiently? If so, an alternative ventilation system

may be all that is required (see “Ventilation” in Section 10). Note that closing windows can reduce noise by 10 dB(A) or more, i.e. the loudness can be halved.

If the house plan allows, then experiment with transferring noise sensitive activities, such as sleeping, to quieter rooms furthest away from the noise source. On the basis that children are less likely to be disturbed by traffic noise than adults, then swapping bedrooms may be worthwhile. If you decide that further action is required, then it is suggested that improvements to the acoustic performance of the house be done in stages until the sound level becomes acceptable.

The overall noise insulation value of a structure is related to the insulation performance of its parts. There is no point in improving the noise reducing properties of one part of a building, if other parts of the building have much lower noise reducing properties.

For example, there may be little value in installing the highest grades of windows in a weatherboard house unless the walls were upgraded also.

As improving the acoustic performance of a house can be expensive, it is suggested that action be taken in stages trying the simplest and cheapest methods first. Should expensive treatments be involved, such as in extensive double glazing, then the advice of an acoustic consultant should be sought.

8. Noise Barriers Principles

A noise barrier is an obstacle placed between a noise source and a receiver which interrupts the path of the noise. Barriers can reduce noise levels in outdoor living areas by about 5 to 10 dB(A). However, they are not as effective as insulation at reducing indoor noise levels. Barriers may take the form of earth mounds or fences made of various materials including concrete blocks, bricks, timber and fibre cement sheeting.

The choice of a particular alternative depends upon consideration of space, cost, aesthetics and the desired level of

sound reduction. The higher the fence the better, although your local council should be consulted regarding restrictions on height, location and any other requirements. Generally, the height allowed without a special permit is 2 metres above the footpath level.

To be effective a barrier must block the “line of sight” between the noise source and the receiver. A barrier must also be continuous and solid, with few, if any, holes, cracks or openings. In choosing to erect a high fence a resident should appreciate that shielding from passes-by can make an unattended home more prone to burglary.

Materials

Bricks and concrete blocks have the best sound reducing properties. However, lighter materials are generally sufficient for a fence because the limiting consideration is that noise passing through the barriers should be negligible compared to that which will pass over the barrier and around the ends.

In a simple suburban situation where the ground is level, the traffic noise could be reduced by up to 10 decibels if negligible sound came through the barrier.



A Monolite fence consisting of wire reinforced polystyrene panels and posts, rendered with a coloured concrete and textured finish.

For such a situation the barrier material should be dense enough to reduce the transmitted sound by at least 15 dB(A). The material should weigh at least 10 kilograms per square metre. Glass fibre Reinforced Cement (GRC) sheets and 20mm pine planking are dense enough to meet this requirement. The material must also be strong enough to meet the construction requirements set out in the next section.

Construction

Fences must be solidly built to be effective as noise barriers. There must be no clearance gap under the fence, and planks or sheets must be tight fitting so there are no cracks. Consideration must also be given to the ageing and warping of timber, and fences should be designed to avoid gaps developing due to warping over time.

Hints for building solid timber noise fences:

- (i) place posts at close intervals, at the most 2.5 metres for rigidity;
- (ii) use three horizontal support rails on a vertical timber fence or cement sheet fence. Alternatively, use two rails with closer post interval, say 2 metres;
- (iii) overlap horizontal or vertical planks by 35mm;
- (iv) use galvanised bolts and nails, the former for preference. Where nails are used, drill holes to prevent cracking;
- (v) if necessary bolt a support strip to planks between posts to pull planks together;
- (vi) bury the bottom of the barrier; and
- (vii) use treated timber or apply a preservative, (environmentally friendly materials is preferable).

The driveway must be effectively blocked off, too, if the benefit of the fence is not to be lost. Solidly built gates, of the same height as the fence, with rebated meeting edges can be installed. An alternative to having gates is to return the fence along the house side of the drive.



The timber fence and gate shown illustrate solid effective construction although the gap beneath the gates could be lessened.

Two methods of constructing a solid timber fence.

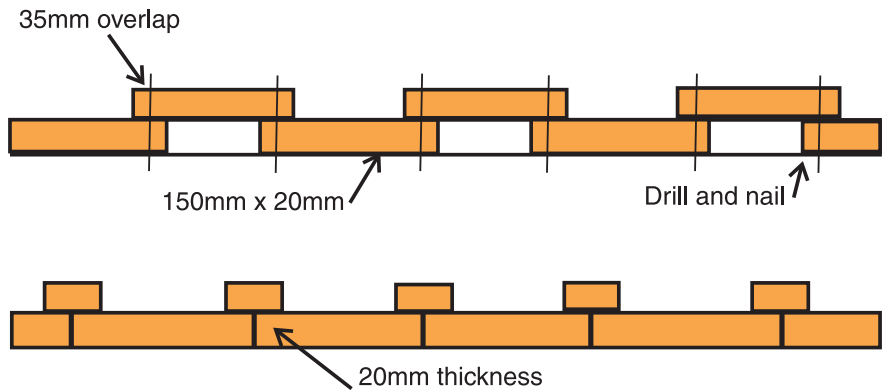

The construction illustrated is inadequate for a noise barrier although suitable if only privacy is required. The fence, to be effective as a noise barrier, would need additional planks overlapping the gaps.

Location

Since the source of traffic noise is in effect a long line, a noise barrier fence needs to be very long if sound is not to reach the listener via each end. For this reason a householder wishing to erect a high fence near the front of his property should try to persuade his neighbours to erect similar fences or, alternatively, return the fence down the side boundaries.

It may be possible to increase the effective height of a barrier by erecting the barrier on rising ground.

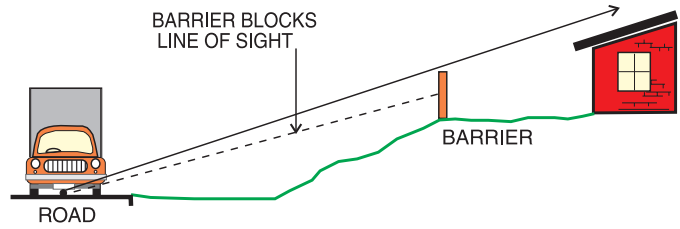

The barrier above is placed to make use of the land form and so increase its effective height. The diagram below shows how a poorly placed barrier is of reduced effectiveness

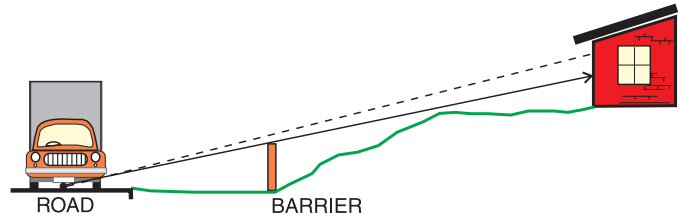

Screen Walls

Long solid walls or fences around the property boundary can be expensive. The use of external screen walls can offer an economical alternative for achieving noise reduction and privacy particularly if only a window or a small outdoor living area is in need of shielding.

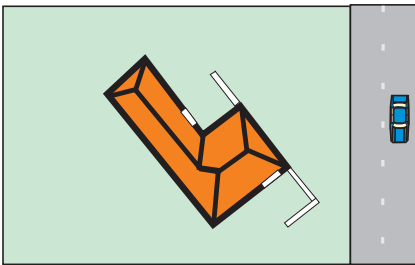

Some protection may be possible even if certain views or sun penetration are important

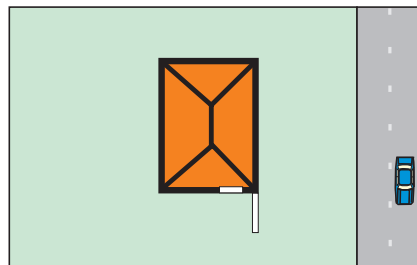

Protection for windows at the side or back is easier and less expensive. This design is not as good as below.

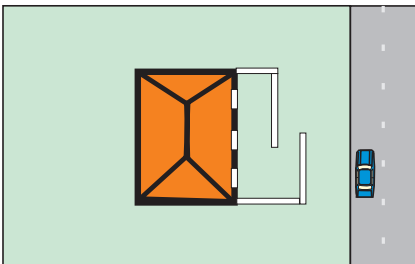

If views are not as important as traffic noise, this type of patio screen wall affords good protection without excluding too much sun. Privacy and wind protection are a bonus.

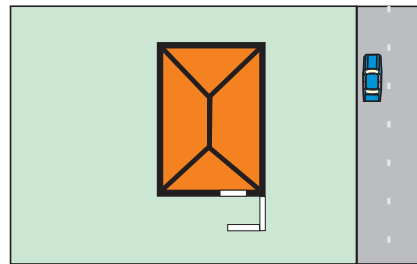

A small right angle return on the fin wall significantly increases the protection to this side window.



These photos illustrate external screen walls which protect outdoor living areas. By not locating the walls on the boundary, their length, and hence their cost has been reduced. The balance of the land has been plated to soften the walls.





The residential development makes use of brick walls to create private living areas. The higher screen wall on the right provides shielding from traffic noise for an outdoor living area.

Aesthetics

Materials used for a noise barrier should be chosen for appearance as well as cost and effectiveness.

Location and design are also factors to consider in ensuring that a fence is in harmony with the surroundings.

The visual impact or appeal of a fence as seen from the street is as important as the view from within the property. An attractive streetscape enhances the value and appreciation of homes within the area. Planting of small trees and shrubs and setting back or stepping a fence can avoid the uniform monotony of fence after fence of the property boundary.



Part of the wall has been stepped back to permit planting. Creepers have also been used to enhance the appearance and soften the hard lines of brickwork

9. Earth Mounds and Vegetation

Earth mounds are usually restricted to use by the road authority. Sufficient land has to be available and the large quantities of earth required, close at hand. Generally only house owners with large sized lots could fit an earth mound. However, small variable mounding may complement a fence.

Vegetation can reduce traffic noise. To be effective as noise reducers, tree and shrub buffers need to be 15 to 30 metres wide, 4-5 metres tall and have dense foliage. With normal house setbacks vegetation would not cause a measurable reduction in noise, but may create psychological benefits for residents. Screening a road with trees and shrubs is an economical and pleasant way of improving the environment. By removing the noise source from view, planting can reduce people's awareness of traffic and also reduce the annoyance it causes.



The whole wall (above) has been set back a metre or so to provide a substantial area for planting. The wall has been painted white to provide contrast with the vegetation.



An earth mound which was built during freeway construction gives adjacent residences some shielding from traffic noise.

10. Sound Insulation of Buildings

Principles

The terms sound absorption and sound insulation are often used interchangeably, but they refer to quite different aspects of noise control. Furthermore, the materials used to achieve good insulation are usually poor absorbers and vice versa.

Good insulating material will be nonporous tightly joined, heavy, and resist the passage of sound by reflecting the incident sound. Good sound absorbing materials are porous, fibrous or cellular with continuous air passages deep into their interior or even right through, e.g. glass wool, rock wool, and cellulosic fluff.

Insulating barriers, when installed in buildings are used to minimise sound passing from one space to another whilst absorbing surfaces are used to “mop up” sound within spaces. Barriers consisting of multiple layers, with air spaces and porous material in between, give the best performance for a given total weight.

It is important that any sound insulating project on a home include good sealing of doors, windows and at edges of insulated walls and ceilings. Cracks and gaps can significantly reduce the effectiveness of insulation. Some danger points for close attention are as follows:

- holes cut for pipes, ducts, conduits;
- timber jambs around doorways, particularly in masonry walls;

- metal window frames in masonry walls;
- bedding gaskets for doors and openable windows;
- cracks under doors; and
- ventilation openings in walls.

Anyone intending to insulate an existing house should have regard to how much noise is entering the house via windows, doors, roof etc., before making a decision on what to do, e.g. it would not be worthwhile spending a lot of money upgrading the windows to a very high standard if a significant amount of noise is entering through the roof and ceiling. The best solution would be to spend some of the available money upgrading the windows and some on insulating the ceiling.

When building a new home in a noise affected area people should carefully consider what noise reduction measures can be included during design and incorporated during construction. Insulating a home against noise after it is built will be much more expensive.

Windows

The Victorian Building Regulations require that every habitable room (bedrooms, living rooms, dining room) must have window proportionate to the area of the floor.

Ventilation must be provided by either natural means or by an approved mechanical ventilation or air-conditioning system. The choice of natural ventilation requires that there be openable windows equal to 1/10th of the floor area of the room.

The improving of the sound insulating value of a window can be done in two stages.

1. Close and seal existing windows and install alternative ventilation.
2. Reconstruct the window by modifying or replacing it.

Stage 1

In some cases it may be possible to seal an existing window completely if allowed by the building code. Such windows should be firmly fixed and sealed at the edges with a silicone rubber sealant.

Close attention should be given to the fitting of the window within the wall and any gap between frame and wall should be plugged with suitable filler or sealant. Glass in existing windows may only be 3mm in thickness. Thin glass such as this can be replaced with thicker glass with higher sound insulating properties (See Table 1).

The diagrams following show how existing windows may be sealed.

The diagrams are only intended to illustrate sealing principles and methods. Locally available windows and sealing products may differ from those shown but still achieve the desired noise reduction.

Stage 1 level of treatment would be suitable for weatherboard houses; little would be gained by implementing Stage 2 unless the sound insulation value of the external walls is improved also.

The following diagrams illustrate sealing methods for openable windows. An alternative ventilation system can be developed (see Ventilation Section) so that windows can be kept closed when the room is occupied.

Table 1

| Possible Noise Reduction dB(A) | Type & Thickness of Glazing | Type of Window |
|--|---|----------------------------|
| 5 to 15 | Any type of window when open (depending on size of opening) | |
| Single Glazing: Closed | | |
| Up to 20 | 3mm glass | Openable, no seals |
| Up to 25 | 3mm glass | Fixed, permanent seals |
| Up to 25 | 4mm glass | Openable, weather-stripped |
| Up to 30 | 6mm glass | Fixed, permanent seals |
| Up to 35 | 12mm glass | Fixed, permanent seals |
| Double Glazing: Closed (100mm separation) | | |
| Up to 30 | 4mm + 4mm glass | Openable, weather-stripped |
| Up to 35 | 6mm + 6mm glass | Openable, weather-stripped |
| Up to 40 | 6mm + 6mm glass | Fixed, permanent seals |

Sealing of a sliding aluminium window

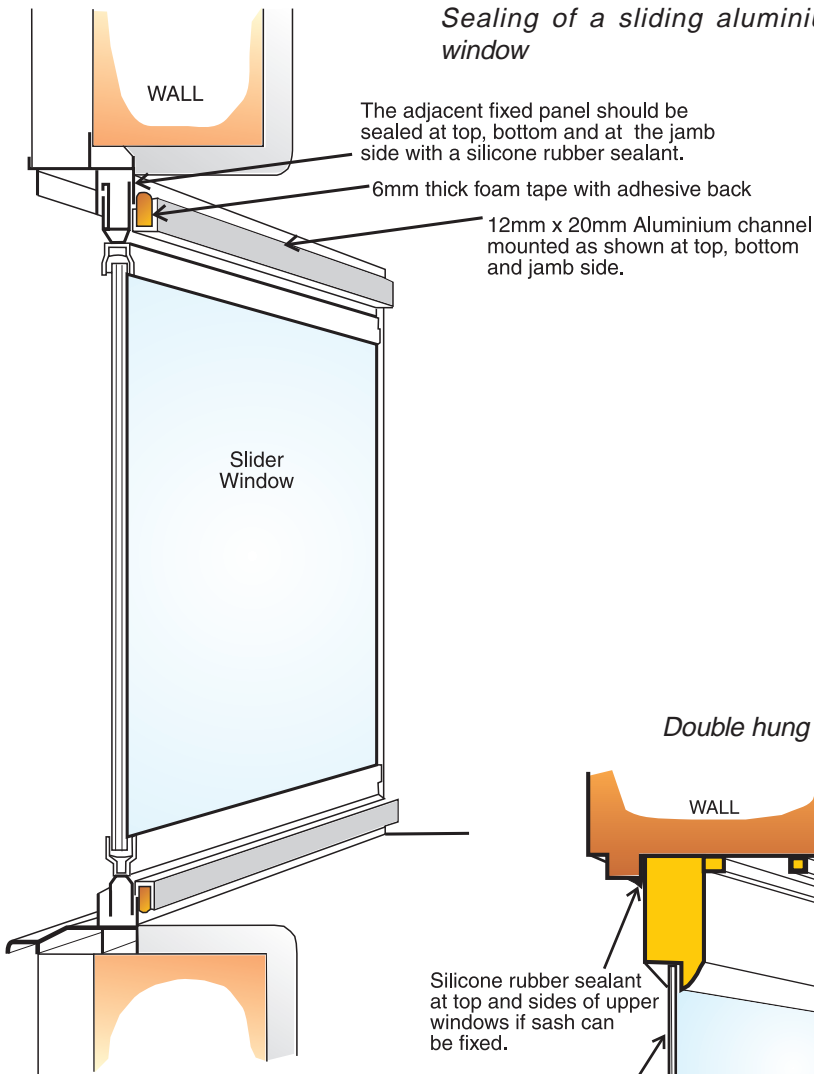

Double hung timber window with seals

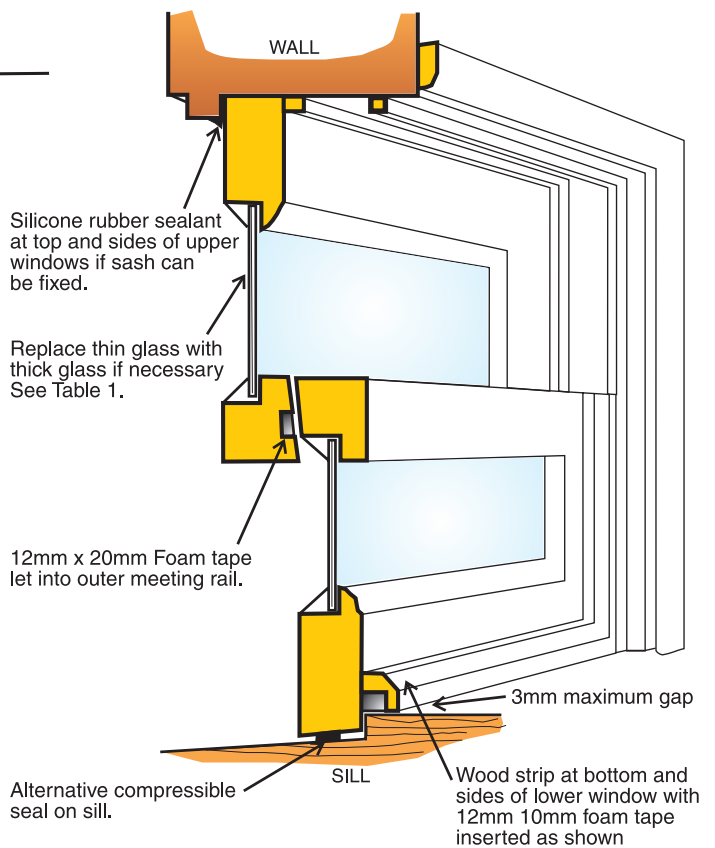

Stage 2

If it is found that sealing existing windows is inadequate then the windows may be double glazed. The effectiveness of double glazed windows is improved by:

- (a) increasing the distance between panes;
- (b) increasing glass thickness; and
- (c) proper use of sealings.

Double glazing can be done in the following ways:

- (a) replacing an existing window with a complete factory made double glazed window unit;

- (b) adding seals to an existing window and fitting an extra conventional window with a wide gap between the two; and
- (c) fitting a lightweight inside glazing unit. Two designs are commercially available, one with a sliding glass panel and another designed for simple fixed window situations.

The inside glazing system uses a P.V.C. frame and fibre seals and is available in kit form from glaziers, or specialist suppliers.

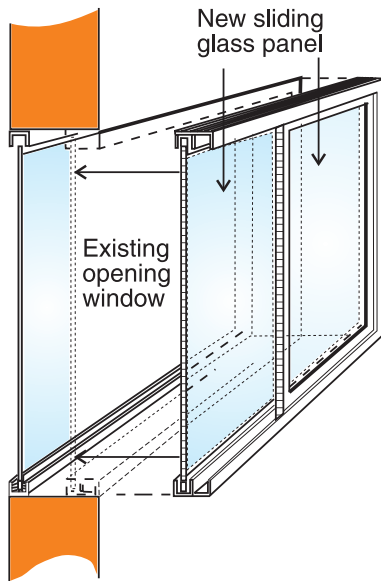

Designed for use with operating windows. This lightweight PVC sliding unit is easily installed and offers an alternative method of double glazing.

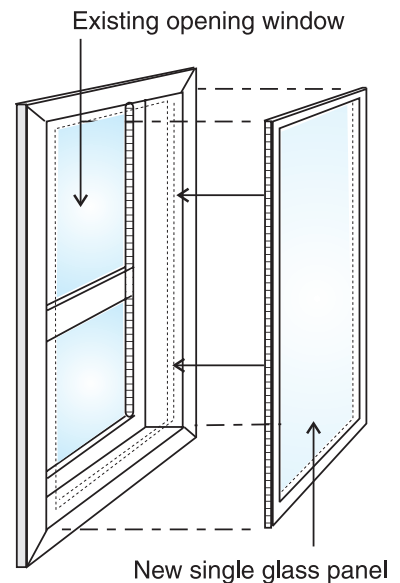

For fixed windows double glazing can be achieved by simply fitting a PVC edge seal to a second pane of glass and then clipping in position.

Double glazing with only about 20mm between the panes (such as that used for thermal insulation) will not give better insulation against traffic noise than a single pane of glass having the same total weight. The air space should be at least 50mm but preferably 100mm or more. Any smaller space is not recommended for protection against low frequency road traffic noise. Increasing the separation from 100mm to 200mm upgrades the acoustic performance by about 3 decibels in each example shown in Table 1. By way of comparison, a halving of traffic volume also results in a 3 dB(A) reduction.

Note that “Openable, weather-stripped” means that some of the panes are openable but special gaskets and cover strips are provided to make them virtually air tight when closed.

Where lack of space does not allow double glazing with a large gap, noise reduction can be achieved by simply selecting a thicker single pane of glass which gives the same performance (See Table 1). The design and condition of the windows must be able to withstand the extra weight of glass.

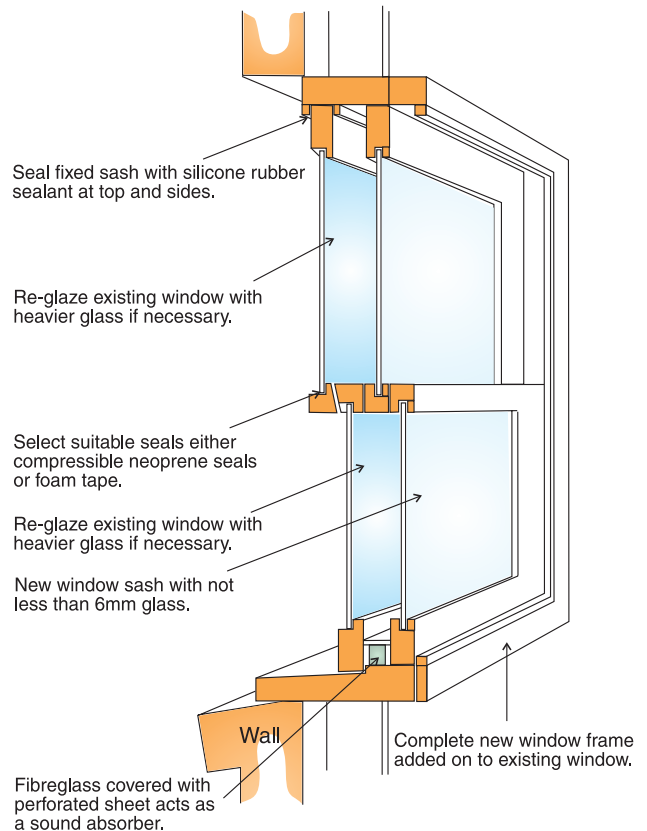
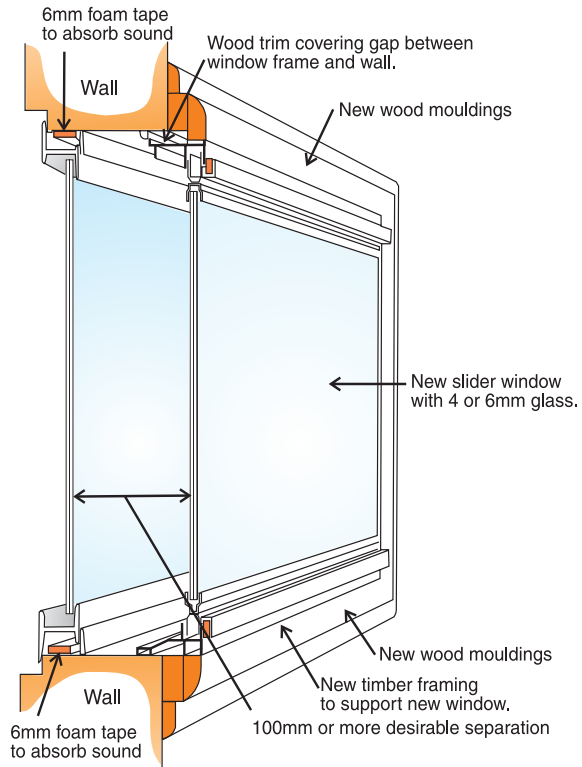

External Doors

The principles of noise insulation for windows applies equally to doors. Doors should be of reasonably heavy material and well sealed around the frame and at closing surfaces.

Stage 1

Hinged doors should be sealed at edges with soft compressible or adjustable seals. An automatic drop seal which drops on to the threshold when the door is closed is effective.

Sliding doors may be sealed in a similar manner to the aluminium window illustrated earlier.

Stage 2

Hinged doors should be replaced with heavier doors with higher noise reduction properties and closer attention paid to sealing and edges.

Sliding glass doors should be modified by the addition of an extra glass door assembly. The new outer door should comprise two sliding panels to allow for cleaning of all glass surfaces. Acoustic seals should be installed on both doors.

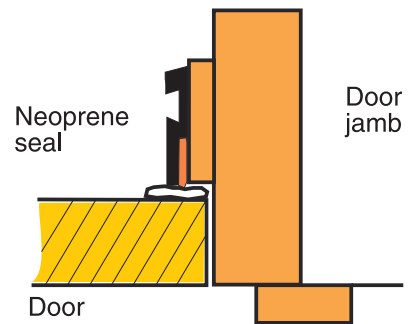
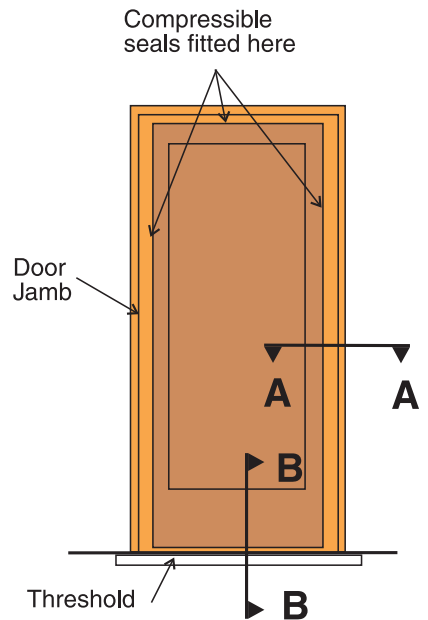

SECTION A - A
Compressible Neoprene Seal for use at sides and top of door frame.

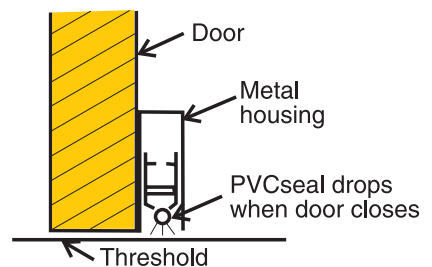

SECTION B - B
Automatic Drop Seal

Ceiling and Roofs

Generally most ceiling and roof combinations provide moderately good insulation against traffic noise. By way of example, a concrete tiled pitched roof and a 9mm plasterboard ceiling reduced traffic noise by up to 27 dB(A). To improved the sound reduction of the ceiling to a level comparable with that of double glazed windows thermal insulation giving an additional 7 to 8 dB(A) reduction should be installed. See Table 2 for the effectiveness of various materials.

The weakest point in a roof and ceiling system is usually where the wall meets the ceiling. With brick veneer construction the outer wall stops at the eaves creating an acoustic weakness in the building shell or envelope. Where high noise reductions are required additional thermal insulation could be placed in the eave space. The same principles apply at skylights as for windows.

Walls

Brick veneer, the most common type of house construction has sufficient sound reducing properties for most situations providing there are no weak components. The effectiveness of a wall can be reduced drastically if components such as ventilators, doors and windows are not a comparable insulating value.

Attention should be given to windows and doors as described earlier. Ventilators can be treated with sound absorbing material and placed on walls not directly exposed to external noise.

For a house under construction, 100mm thick thermal insulation batts placed between the wall studs will improve the acoustic performance by about 5 decibels.

The illustrations on the next page show the approximate reductions in the level of sound of typical suburban traffic which can be obtained from different types of wall construction. The decibel reductions shown assume that the walls are continuous (i.e. unbroken by holes, cracks, windows or doors).

Table 2

| Item | Material | Thickness | Density | Improvement to basic roof Sound level reduction (traffic) dB(A) | |
|------|----------------------------------|-----------|---------|---|-----------|
| | | | | Pitched roof | Flat roof |
| | | (mm) | kg/m | | |
| 1 | Glass wool, low density | 50 | 12 | 4 | 6 |
| 2 | Glass wool, low density | 100 | 12 | 5 | 7 |
| 3 | Rock wool, high density | 75 | 83 | 7 | 9 |
| 4 | Cellulosic fluff, medium density | 120 | 46 | 8 | 9 |

(Table is reproduced courtesy of the CSIRO Division of Building Research.)

Floors

No modifications are normally necessary. To improve the noise reduction through the floor in conventional weatherboard houses, the spaced board sections of underfloor walls should be replaced with some form of solid heavy board with normal underfloor venting.

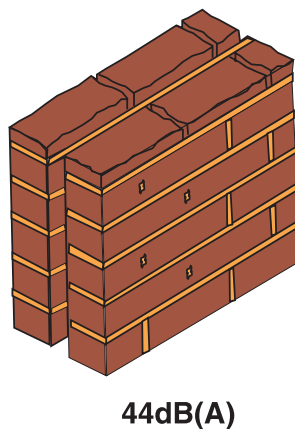
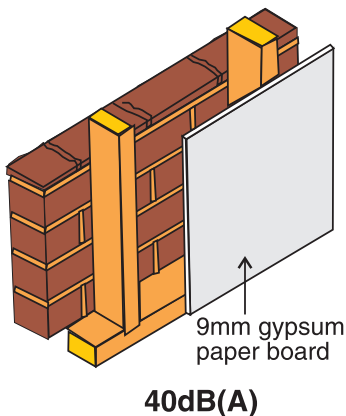
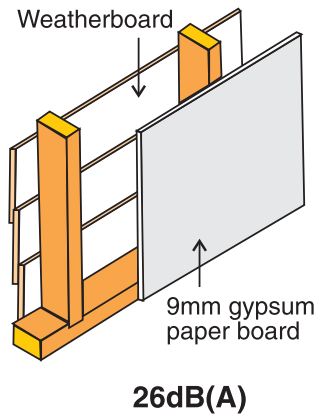
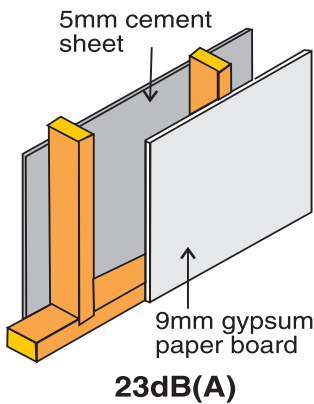

Ventilation

As stated in the section on 'Windows', the Victorian Buildings Regulations required that for natural ventilation the area of openable windows in a habitable room be not less than 1/10th of the floor area. Because it is necessary to keep windows closed for effective noise protection, alternative ventilation must be provided for when the room is occupied. The alternative ventilation may take the form of:

- (a) air conditioning;
- (b) mechanical (fan) ventilation; and
- (c) natural air flow through vents.

(a) *Refrigerated or reverse cycle air conditioning* may be appropriate where other factors such as climate add justification to the expense. An air conditioner may lessen the annoyance caused by traffic noise by producing a constant background masking noise. Sound will pass through a conventional air conditioner, therefore some external shielding may be required if the unit is mounted on wall exposed to traffic noise or a split system installed. The effect on neighbours of noise from the unit should also be considered.

(b) *Mechanical ventilation.* Specifically designed low-noise fan units, suitable for continuous operation if desired, are available commercially. Outside air is drawn through a sound absorbing unit which incorporates air filters, and blown into the room at a selected rate.

Various combinations of ceiling or wall mounted fans and ventilators can be constructed to suit each situation.

(c) *Ventilators.* The provision of sound dampened ventilators may produce sufficient air flow for comfort without a permanent fan installation. A portable fan may be adequate for the periods of hot weather but if found inadequate, from the point of view of comfort and convenience, a permanent fan could be installed.

Vents should preferably be installed on the shielded side of a building or, alternatively, in the floor. The passage of sound through a vent or ducting may be reduced by a combination of sound absorbing linings, baffles and bends. Large chambers with deep sound absorbing material are necessary to reduce low frequency noise.

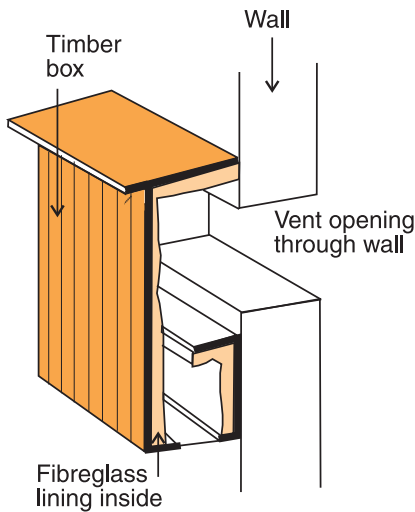

Wall vent with sound absorbing lining suitable for a wall exposed to traffic noise.

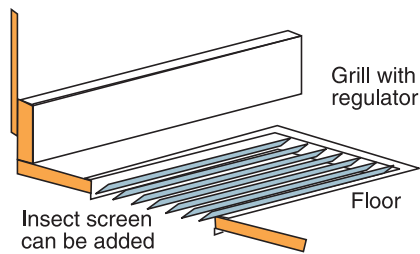

One or more floor vents may give sufficient ventilation for comfort when windows are closed.

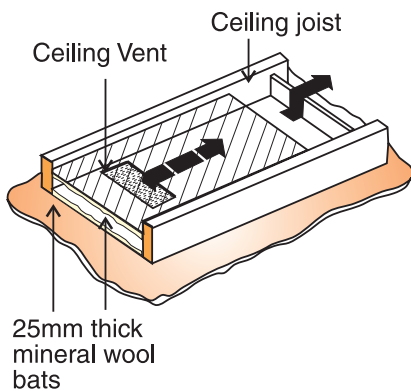

A cut away view of a ceiling vent giving noise attention compatible with ceiling insulation as per items 3 and 4, Table 2

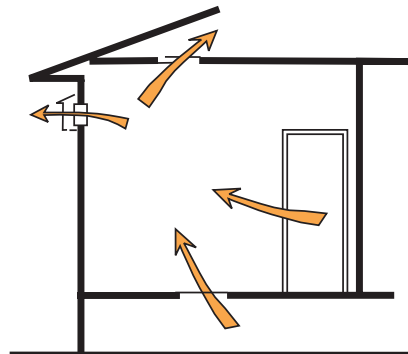

Ventilators illustrated on this page should be positioned which suits the use of the room. Fan assistance may be necessary.

Room Furnishings and Absorption

Once traffic noise has entered a room, sound absorption within the room can reduce the build up of sound from reflections. Heavy curtains, carpets and soft furniture can reduce reflected noise by up to 3 dB(A).

Acoustic ceiling tiles are designed to reduce reflected noise, but will not greatly reduce sound transmission through walls or ceilings to which they are attached. Likewise, heavy curtains do not greatly affect the amount of noise actually coming in through windows. Only about 1 dB(A) benefit could be expected in this way.

In an upper storey dwelling a significant amount of noise may be reflected as shown in the diagrams below. Suitable sound absorbent material can be used to reduce this reflected sound.

The amount of reflected noise experienced outside on the balcony can be significantly reduced by adding sound absorbing material to as many surfaces as possible.

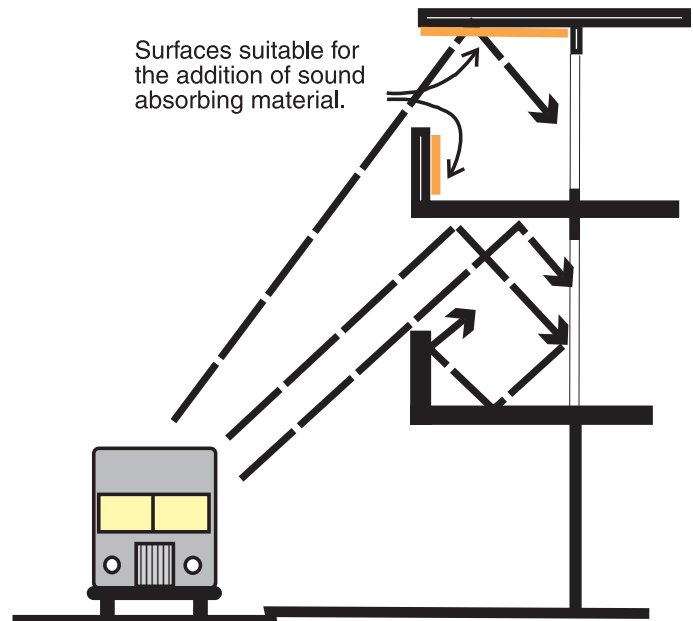

11. Your Responsibility for the Noise Environment of Others

We all contribute to the traffic noise problem - some people more so than others. To limit the noise and corresponding annoyance you cause, it is necessary to maintain your car properly and to develop quiet driving habits.

Considerate driving behaviour can lessen the annoyance felt by residents living alongside roads. Steady traffic noise can often be tolerated but rapidly accelerating or braking vehicles and those with faulty or modified exhaust systems can become extremely annoying. In quiet residential streets erratic inconsiderate drivers become even more noticeable.

Every time you use your car you can help improve the environment of others by:

- (i) gentle acceleration and braking;
- (ii) keep speeds down to legal limits; and
- (iii) drive at speeds not exceeding 40kph in residential streets.

As well as improving the noise environment the above habits will reduce wear and tear on your car and improve fuel economy. You and others benefit.

12. Information on Acoustic Materials

Categories in the 'Yellow Pages' telephone directory under which may be found suppliers of acoustic materials:

- Acoustic Consultants
- Air Conditioning - Commercial and Industrial
- Air Conditioning - Home
- Ceilings
- Doors and Door Fittings
- Fans and Blowers
- Glass Merchants and/or Glaziers
- Insulation Contractors Thermal and/or Acoustic
- Insulation Materials-Acoustic-Manufacturers and/or Wholesalers
- Insulation Materials Thermal and/or Acoustic Retailers
- Sealing Compounds
- Ventilating Equipment and/or Systems
- Weather Seals and Strips
- Windows

Additional Notes on Supplies of Acoustic Materials

Acoustic Ceilings

For acoustic treatment of ceilings to reduce reverberant sound consult 'Yellow Pages' - 'Ceilings'.

Acoustic Consultants

For professional acoustic advice, consultants are listed in the 'Yellow Pages' - 'Acoustical Consultants'.

Acoustic Doors

Generally made to order. Check listing under 'Doors and Door Fittings'.

Door Seals

Check listings under 'Doors and Door Fittings' and 'Weather Seals and Strips'.

Ventilators and Fans

Check listings under 'Air Conditioning', 'Fans and Blowers', and 'Ventilators'.

More detailed advice on the range of products available and those most suitable for a particular application, may be obtained from the Building Display Centre, 332 Albert Street, East Melbourne.

Professional advice is recommended where concern is raised on the acoustic siting and design of new homes and the acoustic design of renovations and may be obtained from acoustic and architect consultants. One may also consult the Royal Australian Institute of Architects Archicentre for advice.

13. Reference for further reading

- *Sharland, I. Woods Practical Guide to Noise Control.* The Print Connection, Sudbury, Suffolk, UK. 1998.
- *Lawrence, A. Acoustics and the Built Environment.* Elsevier Applied Science, London, 1989.
- *Roadside Noise Abatement.* Organization for Economic Cooperation and Development, Paris, France, 1995.
- *Pelton, H. Noise Control Management.* Chapman and Hall, London, UK, 1993.
- *Edited Nelson, P. Transportation Noise Reference Book.* Butterworths, London, UK, 1987.
- *Barber, A. Handbook of Noise and Vibration Control.* 6th Edition. Elsevier Advanced Technology, Oxford, UK, 1992.
- *Kotzen, B and English, C. Environmental Noise Barriers, A guide to their acoustic and visual design.* E&FN Spon, New York, USA, 1999.

The above references may be viewed by the public at the VicRoads Library, 60 Denmark Street, Kew.

